

- 1. Chain pump
- 2. Elm tree pump
- 3. Well Bulkhead
- 4. Pump Well
- 5. Shot Locker
- 6. Locker Access
- 7. Mast Step

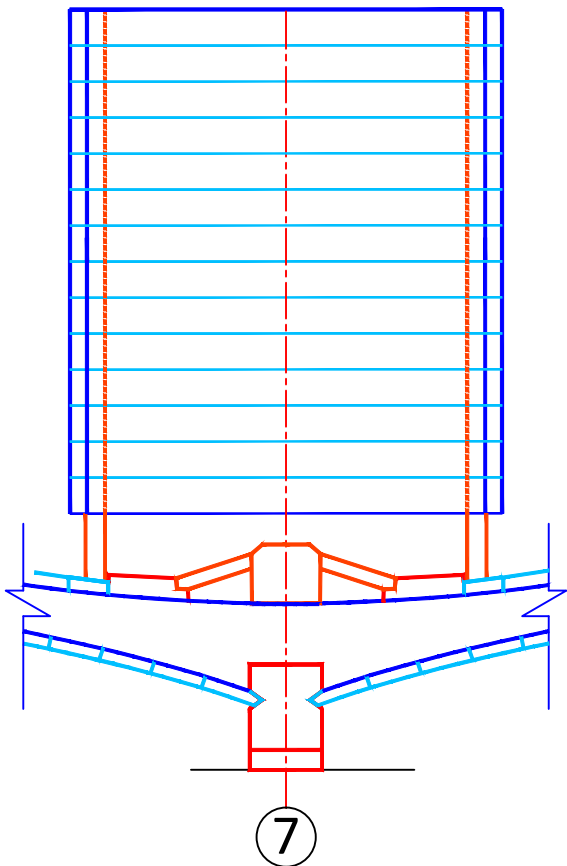

Well End View

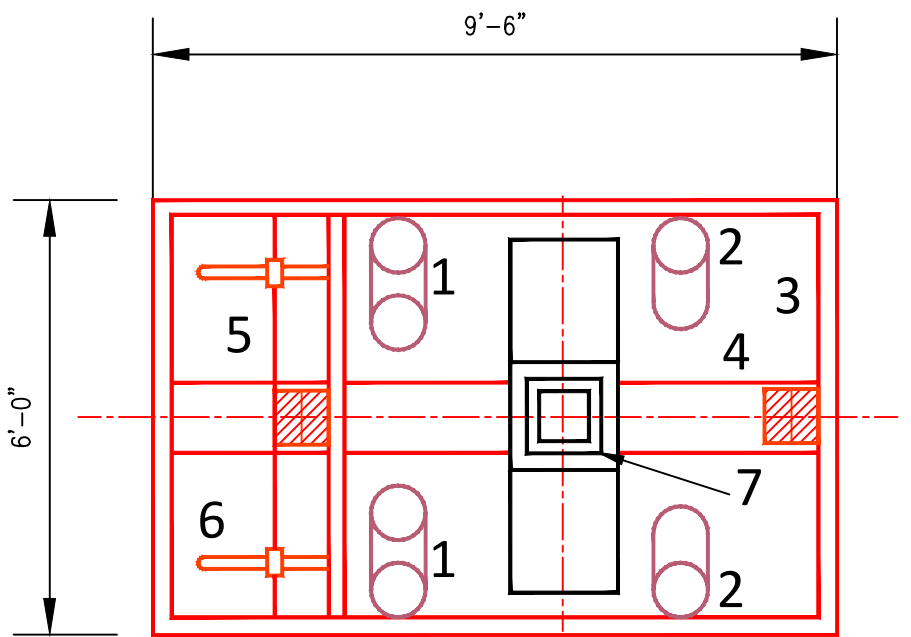

Well Plan

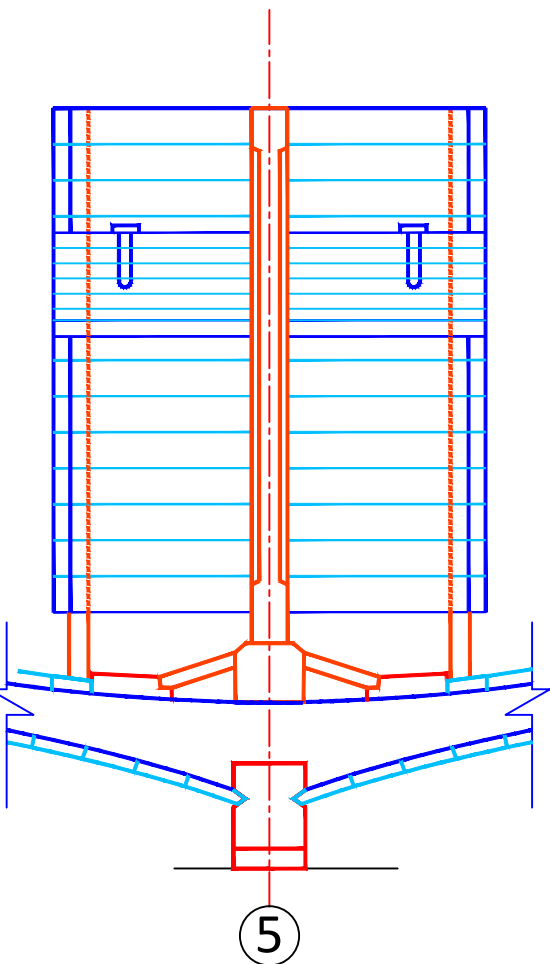
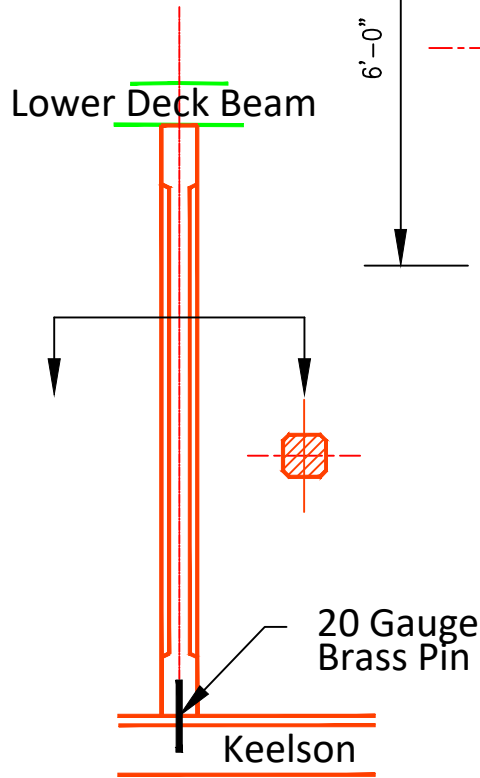

Well Front View

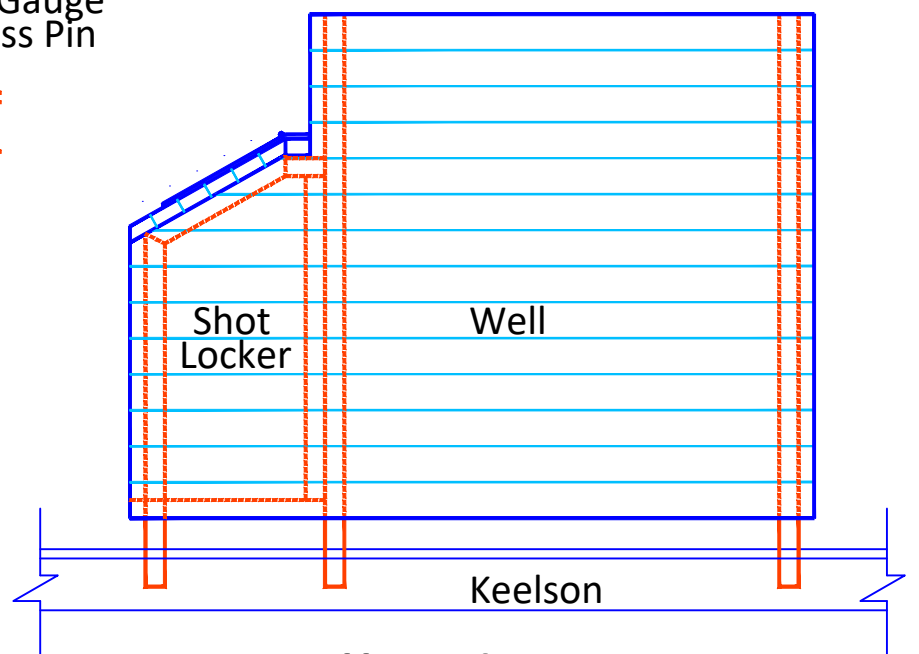

Well Side View
Typ (2)

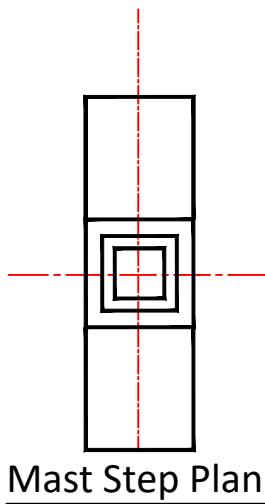

Mast Step Plan

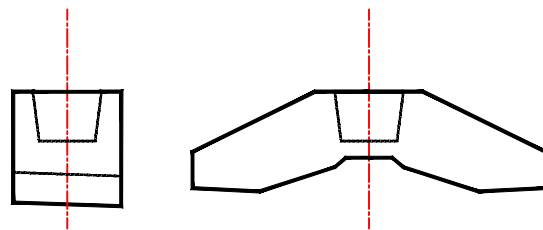

Mast Step Side Mast Step End

Well Details 1:32 sht 1

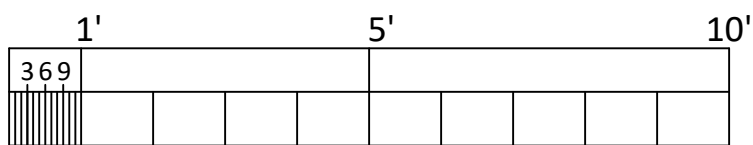

SCALE

10/31/17



Ships of Scale